















3.65-3.1 GARAGE TÄLT

Parts no.		Beskrivning	Antal	Antal
A		Ben	12	16
B		Ben	8	12
C		Gavel hörnbåge	4	4
D		Mitt hörnbåge	6	8
E		Takförstärkning	6	8
F		Diagonal förstärkning	8	8
G		Mitt hörnbåge	8	12
H		Ås	28	42
I1		Dörr monteringsstång	2	2
I2		Dörr monteringsstång	2	2
J		Fästning av duk	10	14
K		Ben	4	4
Z		Ås	7	7
L		Resårstroppar	44	44
M		Beslag	4	4

N		Bult 2.5"	22	22
O		Bult 3"	44	58
P		Dukspännare	20	28
Q			4	4
R			4	4

I Montering av mittbågarna :

- Tag en mittbåge (D) och montera på hörnbågen (G).
- Montera takförstärkningen (E) med bultar och vingskruvar.
- Montera alla mittbågarna.



II Montering av gavel båge.

- Tag en mittbåge (D) och montera gavel hörnbåge.
- Montera takförstärkning (E).
- Montera dörrmonteringstångerna med bultar.



III Res garaget.

- Montera samman bågarna med åsarna (H)(Z).
- Montera benen (A)(B).
- Montera de diagonala förstärkningarna (F).
- Använd beslag och jordspett för att fixera tältet till underlaget.

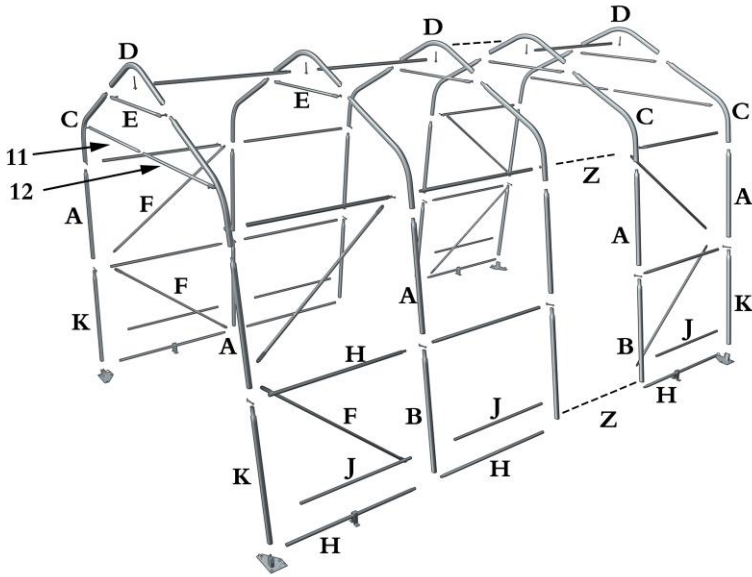

IV Montera duk.

- Bred takduken över stommen.
- Montera duken med dukspännarna (P) och (J).
- Spänn upp duken med repet som går igenom ändarna av tält duken.

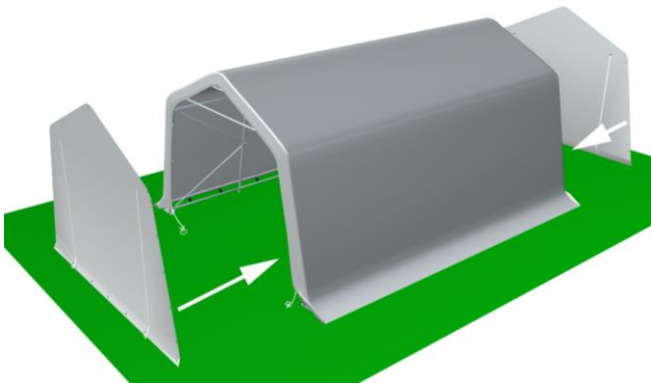
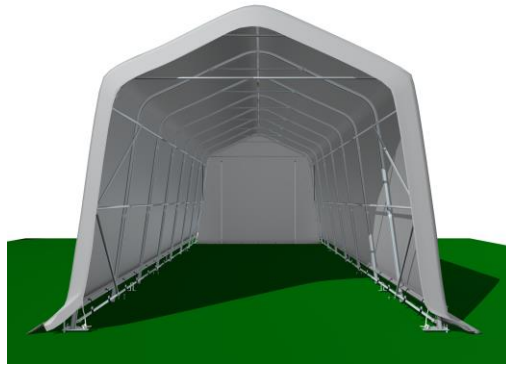

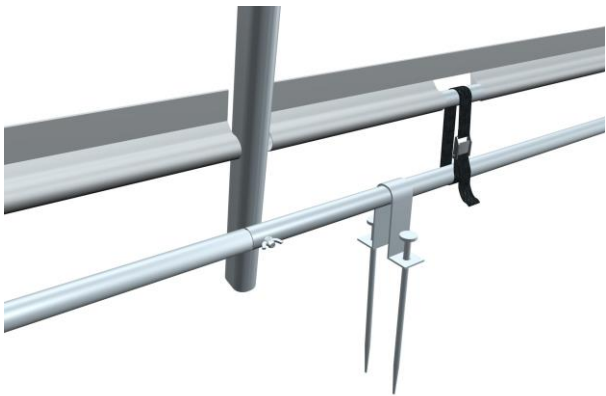



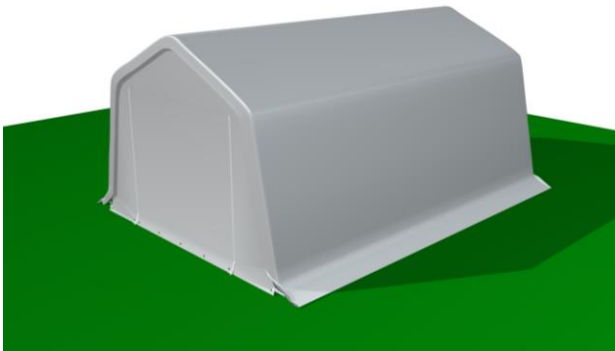











V Montera gavlarna med resårstroppar.



3.65-3.1 GARAGE

Parts no.		Beskrivelse	Antal	Antal
A		Ben	12	16
B		Ben	8	12
C		Gavl hjørne bue	4	4
D		Midter bue	6	8
E		Tag forstærkning	6	8
F		Diagonal forstærkn.	8	8
G		Midt hjørne bue	8	12
H		Ås	28	42
I1		Dør montagestang	2	2
I2		Dør montagestang	2	2
J		Dug fastgørelse	10	14
K		Ben	4	4
Z		Ås	7	7
Q		Elastik	4	44
R		Beslag	4	4

N		Bolt 2,5"	22	22
O		Bolt 3"	44	58
P		Dug strammer	20	28
Q				4
R				4

I Opbygning af midter buer:

- Tag en midter bue (D) og monter midter hjørne buerne (G).
- Monter tag forstærkningen (E) med bolte og vinge skruer.
- Gentag dette med alle midter buerne.



II Opbygning af gavlbuer:

- Tag en midter bue (D) og monter gavlbue hjørne buerne (C).
- Monter tag forstærkningen (E).
- Monter dør montagestængerne med bolte (I1)(I2).

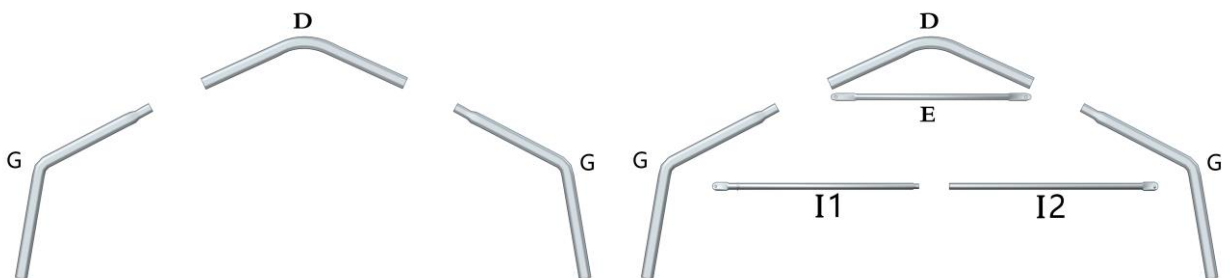

III Rejs garagen:

- Forbind alle buerne med åsene (H)(Z).
- Monter benene (A)(B).
- Monter diagonal forstærkningerne (F).

- Anvend beslag og jordspyd for at fiksere teltet til underlaget.

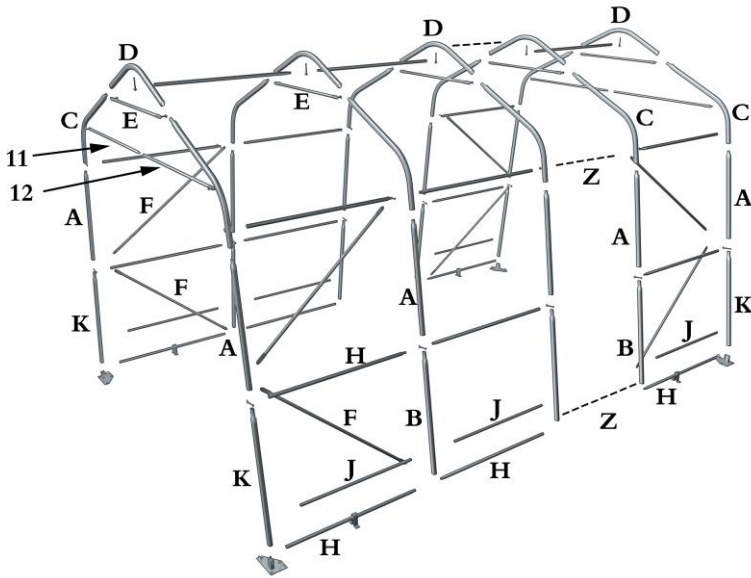

IV Monter duge:

- Bred tag dugen ud over stellet.
- Monter dugen med dug strammerne (P) og (J).
- Stram dugen op med rebet der går igennem enderne af telt dugen.

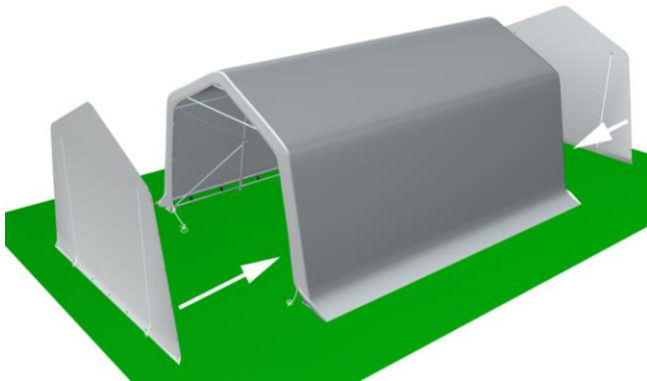
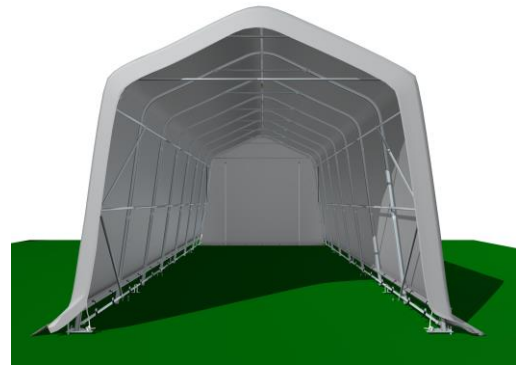

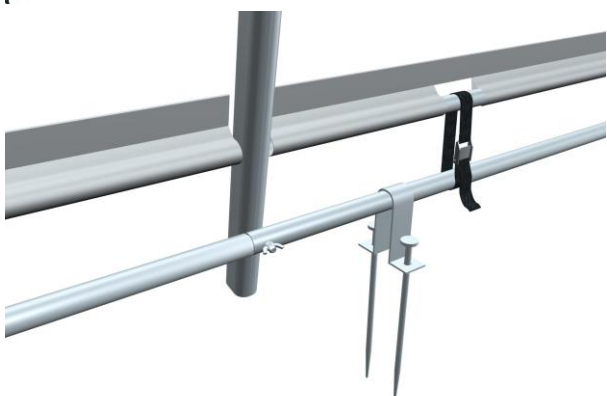

V Monter endevæggene med elastikker.

